

Montageanleitung Call- Center

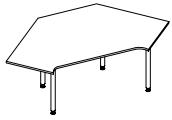

HC 19



HC P6



HS 08

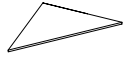

HC P8



HC P5

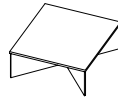

HC 3E



TR 08



TR 05



HC AS



AC 20



AC 30

Stellbeispiel Tische:

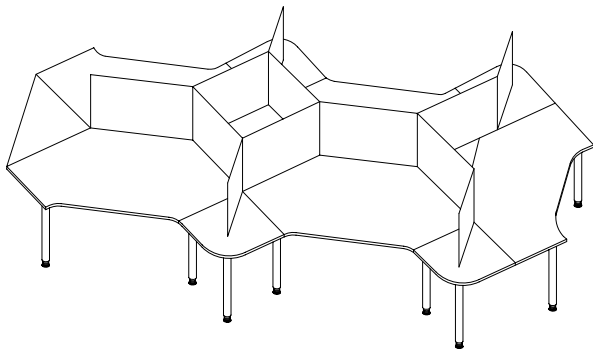
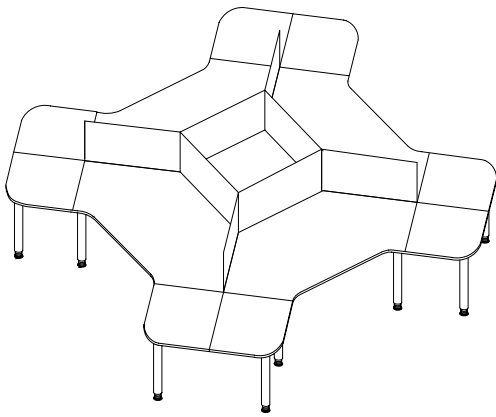

Beispiel Verkettungsbleche :

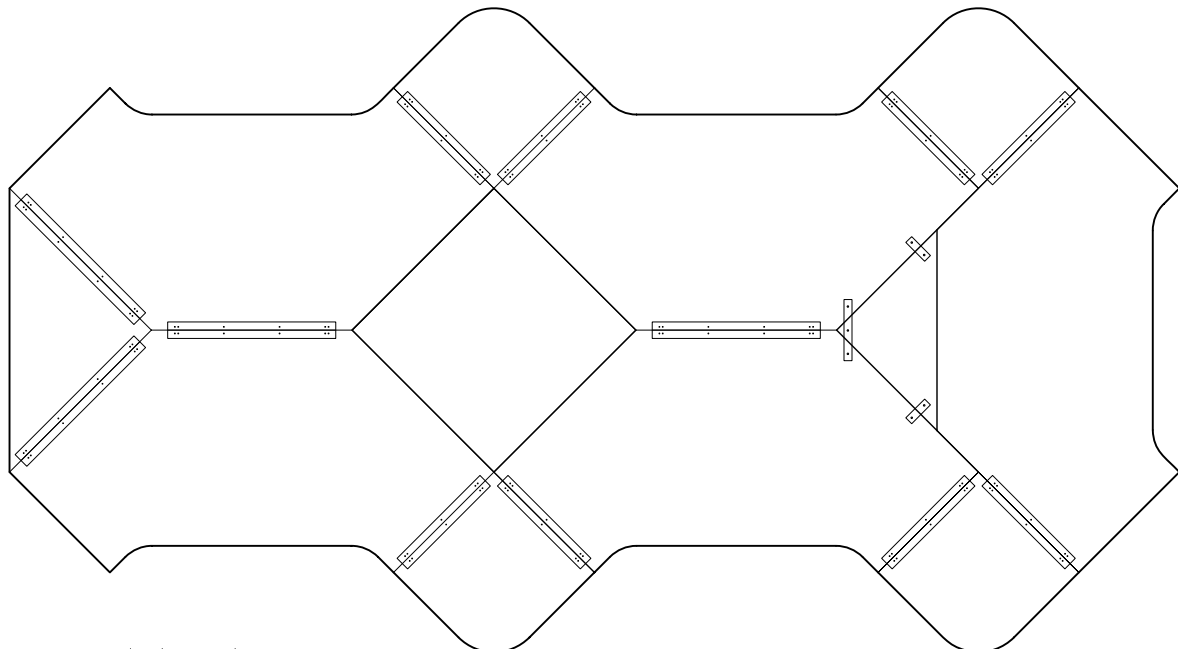
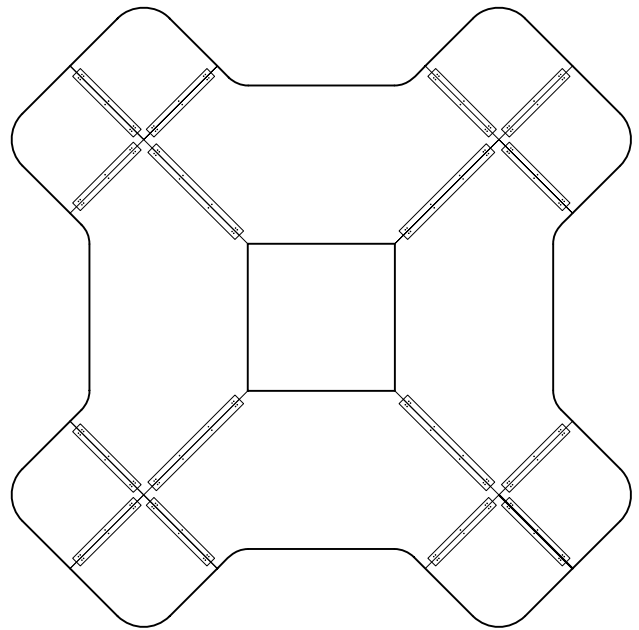



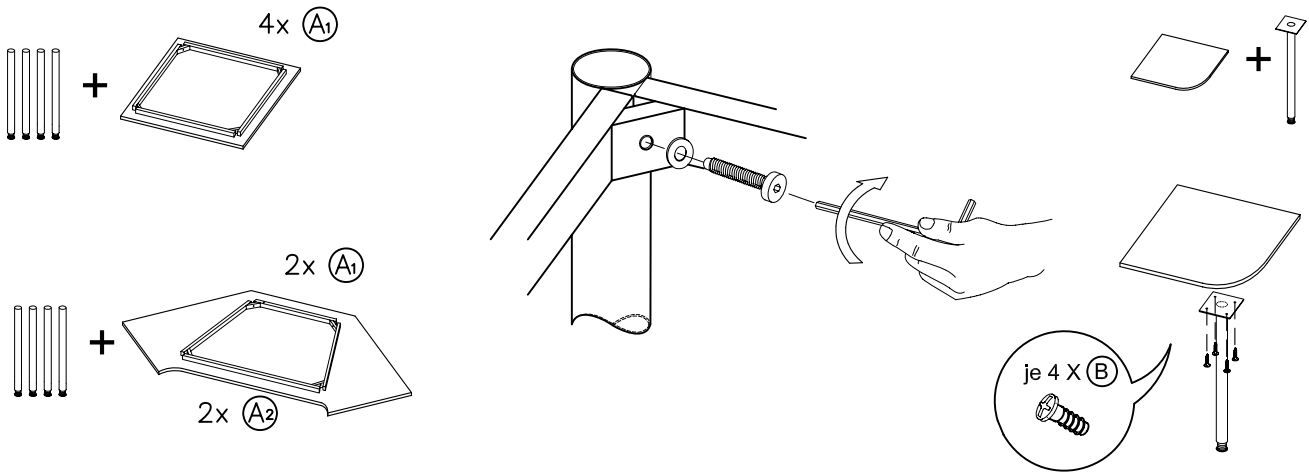
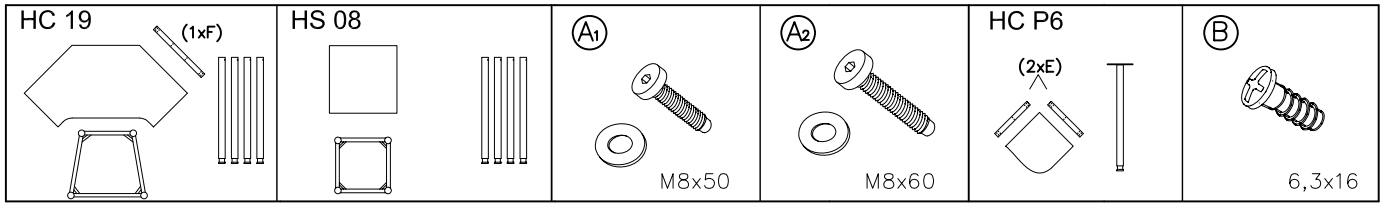

Montage der Tischelemente :

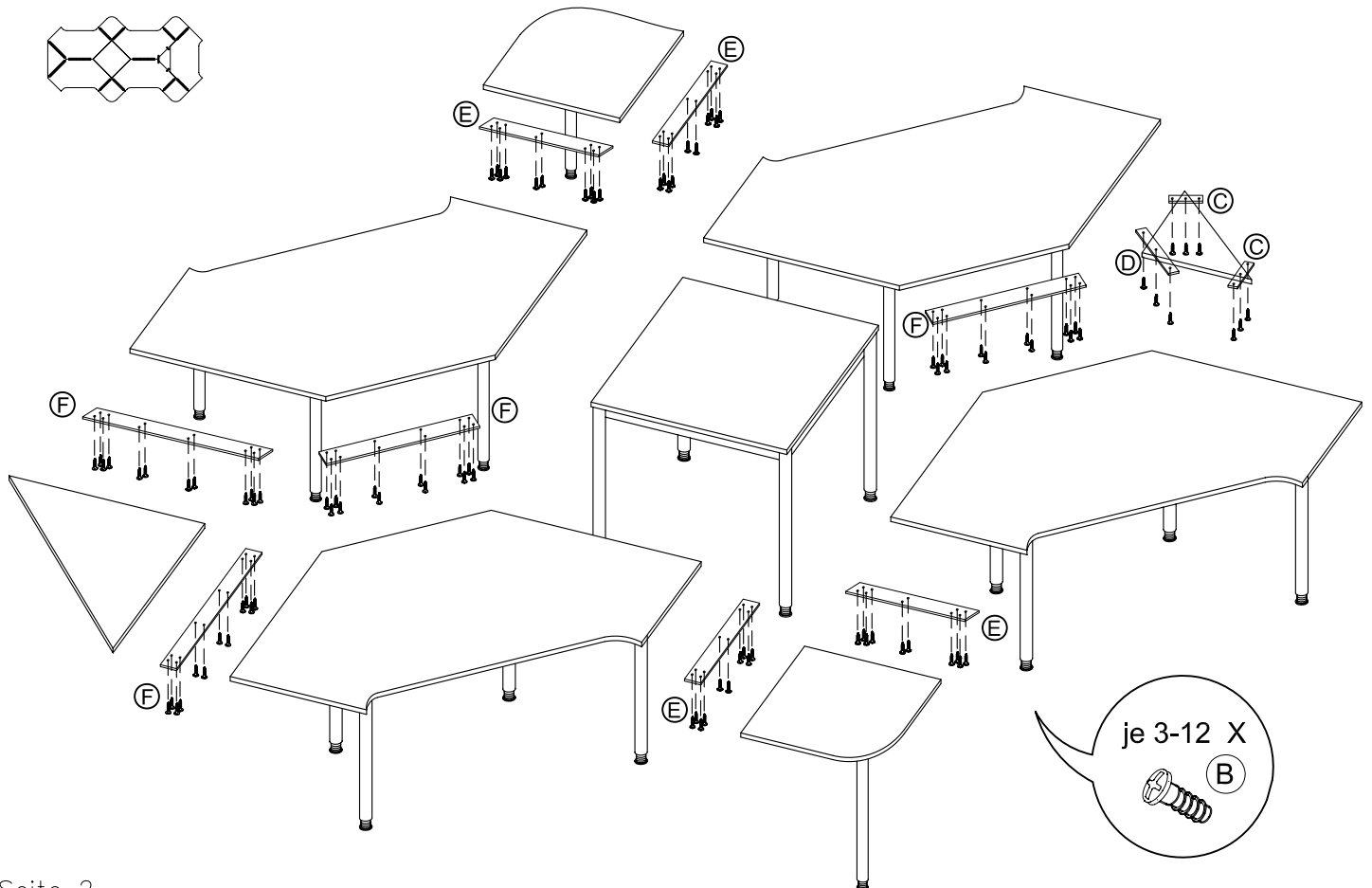
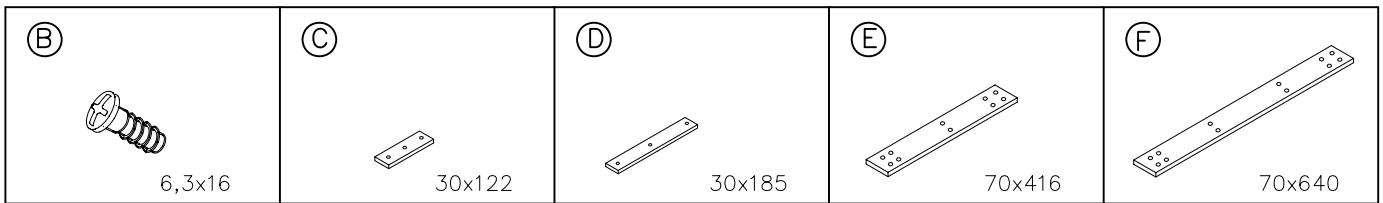

Verkettung :

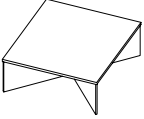
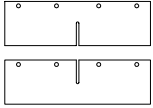
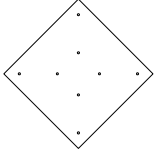

Aktenaufsatz Call-Center

<p>HC 3E</p> 			<p>(H) x 8</p> 	<p>(J) x 8</p> 	<p>(K) x 8</p> 
--	---	---	---	--	--

1.

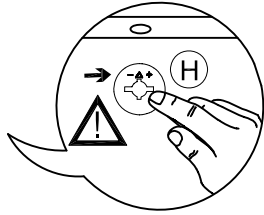
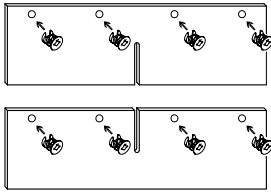

2.

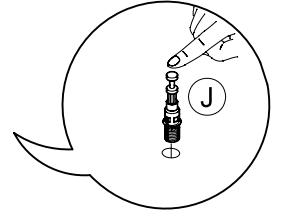
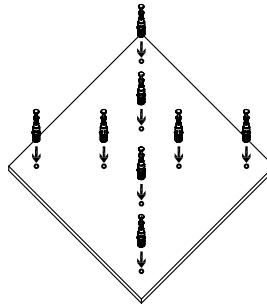

3.

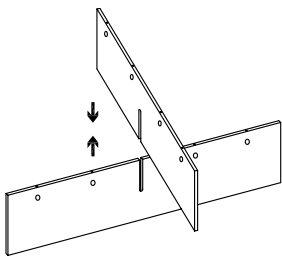

4.

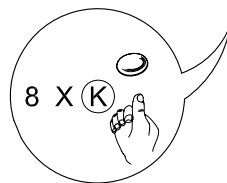
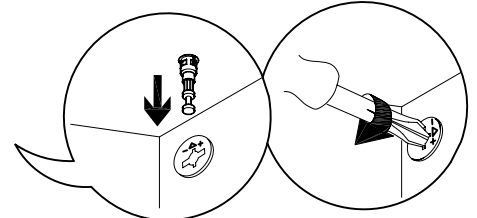
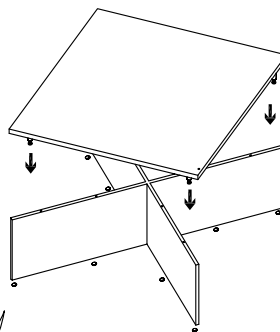

Stellbeispiel :

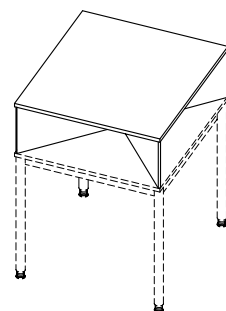
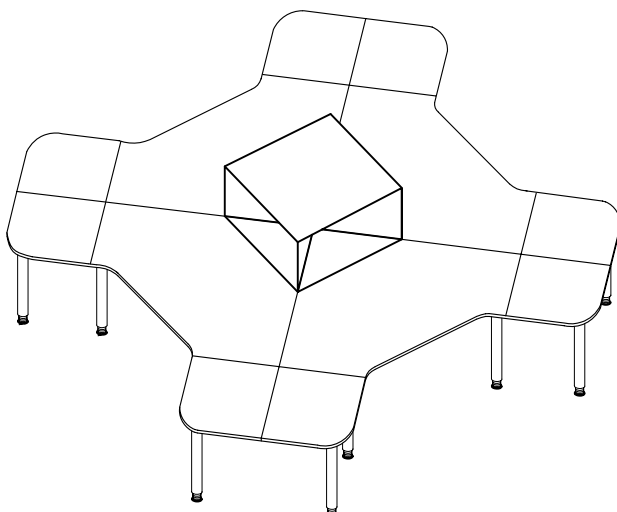

Trennwandsystem

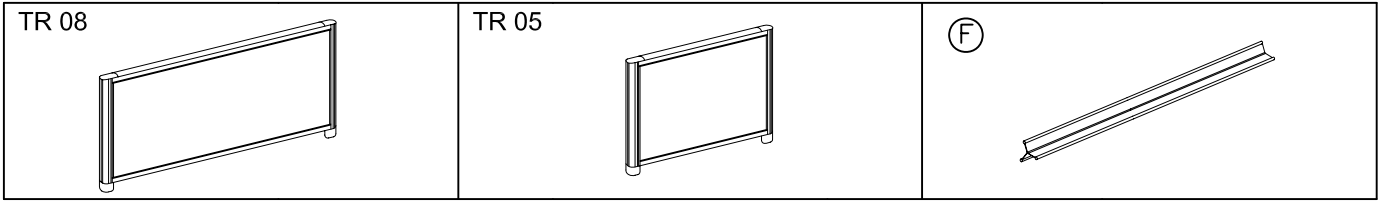

Stellbeispiel :

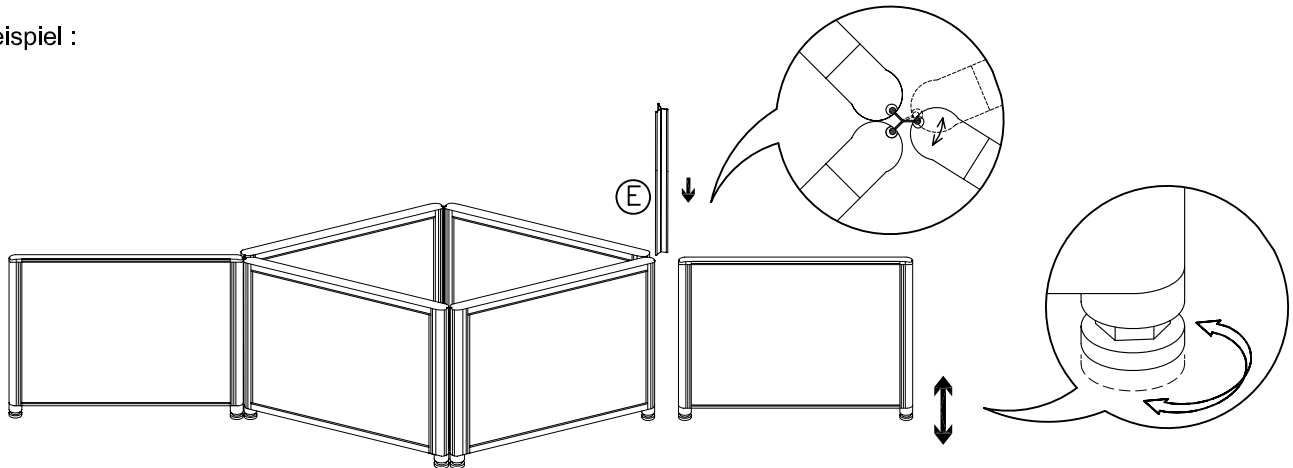

Aktenstütze Call-Center

